

単位:mm

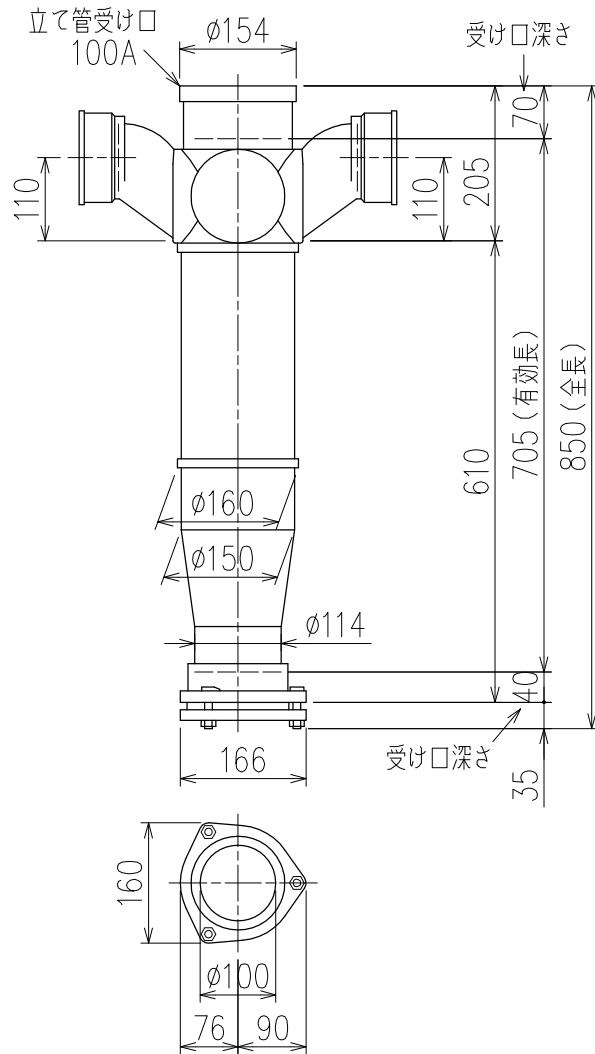
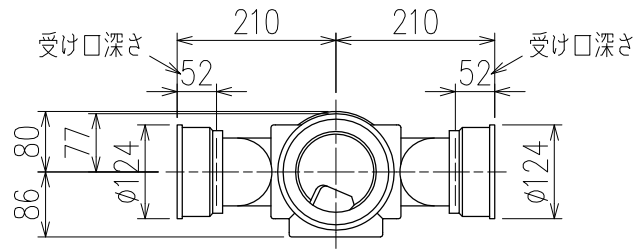

両受けスタイル(W)

<p>図名</p>	<p>4SL2-Z-0タイプ 両受けスタイル 4SL2-Z606-P110-0-W</p>	<p>図番</p>	<p>4SL2-0013-002 </p>
<p>株式会社クボタケミックス</p>		<p>年月日</p>	<p>2016.5.1 S</p>